



-- PVB-75S / PVB-75S-CP --
-- PVB-70S / PVB-70S-CP --
Installation Instructions



Call Jaypro Sports Equipment at 1-800-243-0533 during regular business hours for technical support.

www.jaypro.com

**PVB-75S / PVB-75S-CP
PVB-70S / PVB-70S-CP
PARTS LIST**







ITEM	IMAGE	DESCRIPTION	QTY
1		COVER PLATE <i>P/N: PVB-75CVR (BRASS)</i> <i>P/N: PVB-75CVR-CP (CHROME)</i>	2
2		SLEEVE FOR UPRIGHTS <i>P/N: PVB-75SLV (3-1/2" Sleeve)</i> <i>P/N: PVB70S1 (3" Sleeve)</i>	2
3		#10 x 2" FLAT HEAD PHILLIPS SHEET METAL SCREW <i>P/N: HS5124</i>	8
4		1/2" x 1" SPACER <i>P/N: RP5052</i>	8
5		PLASTIC BUSHING <i>P/N: RP5010</i>	8
6		#10 x 1 1/4" WOOD SCREW <i>P/N: HS5084</i>	8
7		#10-24 x 1" FLAT HEAD MACHINE SCREW, BRASS <i>P/N: HS5302</i>	8
8		#10 HEX NUT w/ STAR WASHER <i>P/N: HN5054</i>	8
ITEM	IMAGE	DESCRIPTION	QTY

Table of Contents

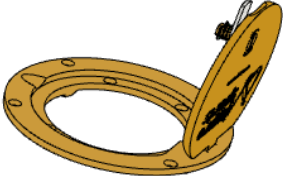
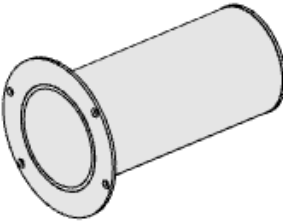
IMPORTANT NOTICE:

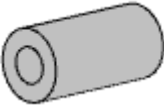
- 1) BEFORE EACH USE CHECK EQUIPMENT FOR PROPER CONNECTING HARDWARE AND STRUCTURAL INTEGRITY. REPLACE DAMAGED OR MISSING HARDWARE IMMEDIATELY.
- 2) NEVER ALLOW ANYONE TO CLIMB OR HANG ON THE NET OR GOAL FRAME. AS SERIOUS INJURY OR DAMAGE TO THE EQUIPMENT MAY OCCUR.
- 3) USE OF THIS EQUIPMENT OTHER THAN INTENDED, MAY BE HAZARDOUS.
- 4) ALTERATION OR MODIFICATION OF THIS EQUIPMENT MAY BE HAZARDOUS AND RESULT IN INJURY. FOR REPAIR OR REPLACEMENT, CONTACT YOUR DEALER OR JAYPRO SPORTS.
- 5) SILICA DUST HAZARD: IT IS WELL KNOWN THAT REPEATED, PROLONG EXPOSURE TO SILICA CONTAINING DUST, SUCH AS CONCRETE DUST, CAN CAUSE SILICOSIS, A DEBILITATING LUNG DISEASE. SILICA IS PRESENT IN CONCRETE AND IS DISCHARGED WHEN CEMENT IS DRILLED OUT, CUT OR BROKEN UP. ONE SHOULD TAKE REASONABLE PRECAUTIONS DURING THE EXCAVATION STEP. SIMPLE PRECAUTIONS, LIKE WARING A P95 MASK, AND CLEANING UP THE MESS IN A WAY THAT DOES NOT BLOW THE DUST ALL AROUND ARE A VERY GOOD START.

Tools Required:

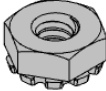
- 6” Core Drill or Rotary Hammer
- Router
- 6 ½” Hole Saw (For Wood Floor)
- Hydraulic Cement (approximately 3, 50 lbs. containers)
- P95 Respirator Mask
- Tape Measure
- Phillips Screwdriver
- 3/8” Wench
- Structural Adhesive (For Synthetic Floors)

- Unpack all parts and check against parts list to ensure that all have been included.
- Inspect all parts for damage. Report any damages to the trucking company.

Important:

Using the proper anchoring material to set the sleeves in place is essential for a good, lasting installation. Use only Hydraulic Cement, also known as Non-Shrink Grout. DO NOT USE bagged concrete mix or similar materials. Hydraulic cement is fast setting, non-shrinking and prevents hairline cracks from forming and propagating. Several brands of hydraulic cement are available at hardware stores. Beware of some that set too fast – under 15 minutes. Rockite® works quite well and provides up to 15 minutes of working time and sets-up in 30 minutes. Other acceptable brands include Embecco 885, Super Flow-Rock®, Master Builders® MasterFlow 713 or 885, Quikrete® FastSet, Sakrete® Non-Shrink Construction Grout.

The following instructions are for installing the floor sleeve and cover on a wood or synthetic floor. See specific instruction for each.

For second floor installations see special instructions for SB-10 or custom sleeve bucket.



Wood Floor

(For wood floors, a router is necessary to remove the proper depth and shape to receive the cover plate.) See next page.



Synthetic Floors

(For installing the sleeve in a concrete slab, tile or synthetic floor) See page 9 of 11.

A. Layout:

1. Find the center of the court, in both directions. Lay out the sleeve locations very carefully, identifying the center point of each. Refer to the court layout drawing, if one exists. For a standard court, the spacing between the sleeves is 36'-0" (center to center). Mark the center of the top cover plate location for reference.

Note: The floor sleeve cover should open away from the court, meaning the hinge is located on the outward side.

B. Wood Floors: (For wood floors, a router is necessary to remove the proper depth and shape to receive the cover plate.)

1. Prepare the top floor surface to receive the cover plate. Draw two concentric circles centered on the center point of each sleeve – one at 6-1/2" and the other at 7-1/2". You can use the cover plate itself, laid face down (upside down) on the floor and trace its outline using a washable pen or pencil. And then offset the line 1/2" in all the way around.

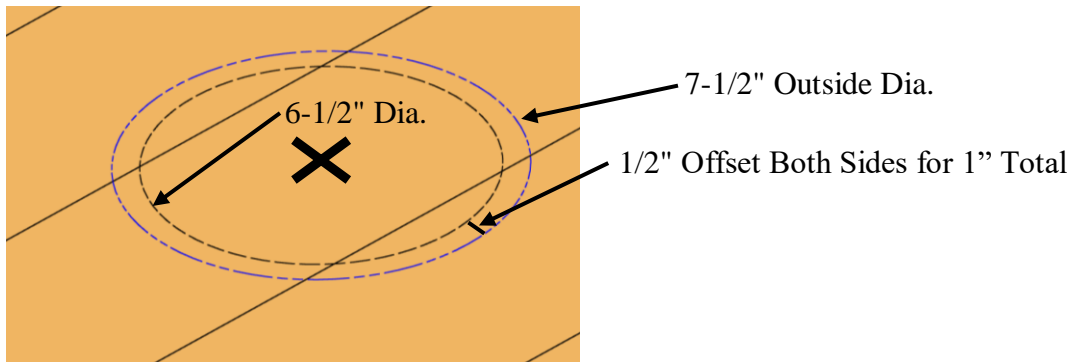

2. Drill a 1/4" test hole to determine how far the concrete is under the floor (not necessary if the flooring is directly on the concrete).

Note: Different template guides are available to help with the routing free-hand routing is discouraged, as one misstep can be very costly.

3. Carefully cut out the inner hole with a hole saw or router.

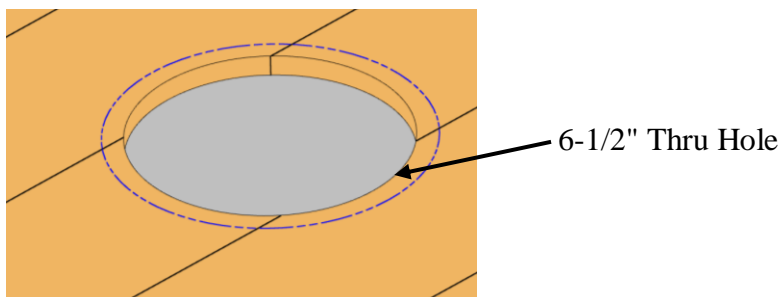

4. Route out the outer lip. Routing depth is very critical, as too deep may result in insufficient wood to attach to, and too shallow will leave the cover raised and exposed, creating a potential tripping hazard.

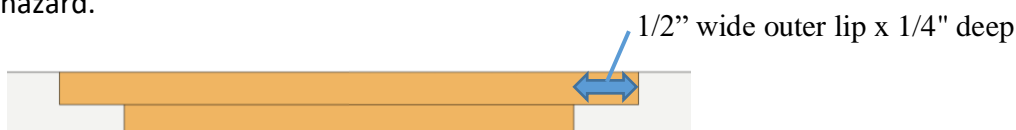

5. Carefully protect the floor, using Masonite or construction paper, taped along the edges. After routing the floor to the proper depth and diameter, fit the cover plate into the hole. Additional routing or chiseling may be required to notch out where the cover hinge is located.

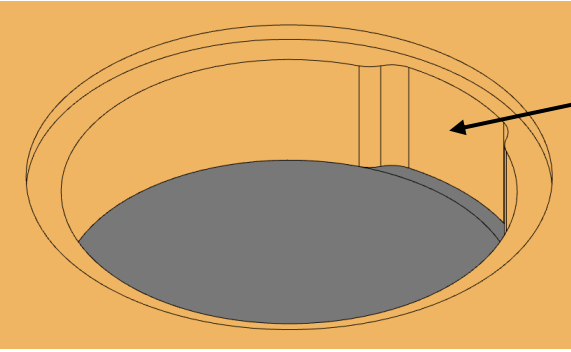

Location of cover hinge should be to the outside of the court.

6. With the wood floor cut open. Drill or chisel a 6" hole in the concrete. A 6" dia core drill is recommended. As the concrete will most likely contain wire mesh, select a core drill meant to cut both concrete and steel, at the same time. With proper equipment, cutting through a 4"-5" concrete slab will typically take between 15-20 minutes. Alternately, an electric or air powered rotary hammer drill can be utilized to drill a series of 1" holes in a circular pattern to create the 6" hole. The disadvantage of this method is added noise and dust.



7. After removing the concrete, excavate the fill material below the slab. Create a minimum 16" deep "mushroom" shaped void to provide sufficient anchoring surface. Remove enough material to accommodate the sleeve, plus a few extra inches all around. Making specialized digging tools can be very helpful to simplify this process.

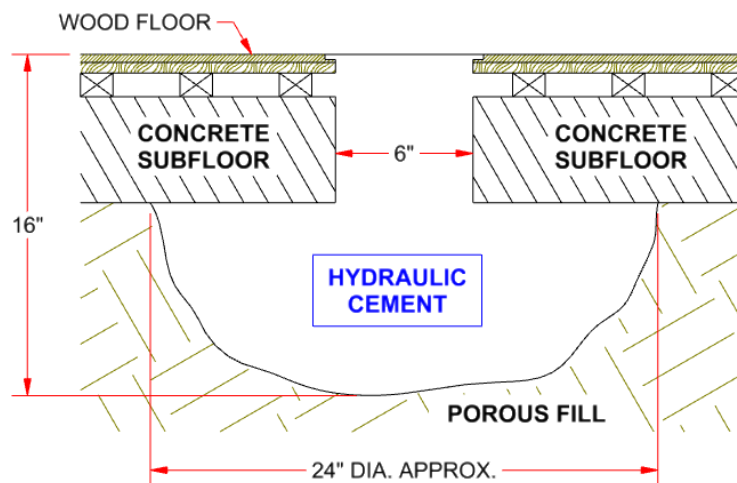

8. Place the cover plate in position and, mark and drill holes into the wood to receive the anchoring screws.
9. Check to make sure the top flange of the sleeve is flat and has not been bent in shipping. Assemble the sleeve with the cover and dry fit the assembly by lowering it into the hole. Check that there is a minimum of 1" clearance between sleeve and concrete to allow hydraulic cement to lock sleeve in place. Also check the fit of the cover so that it is flush with the playing surface.

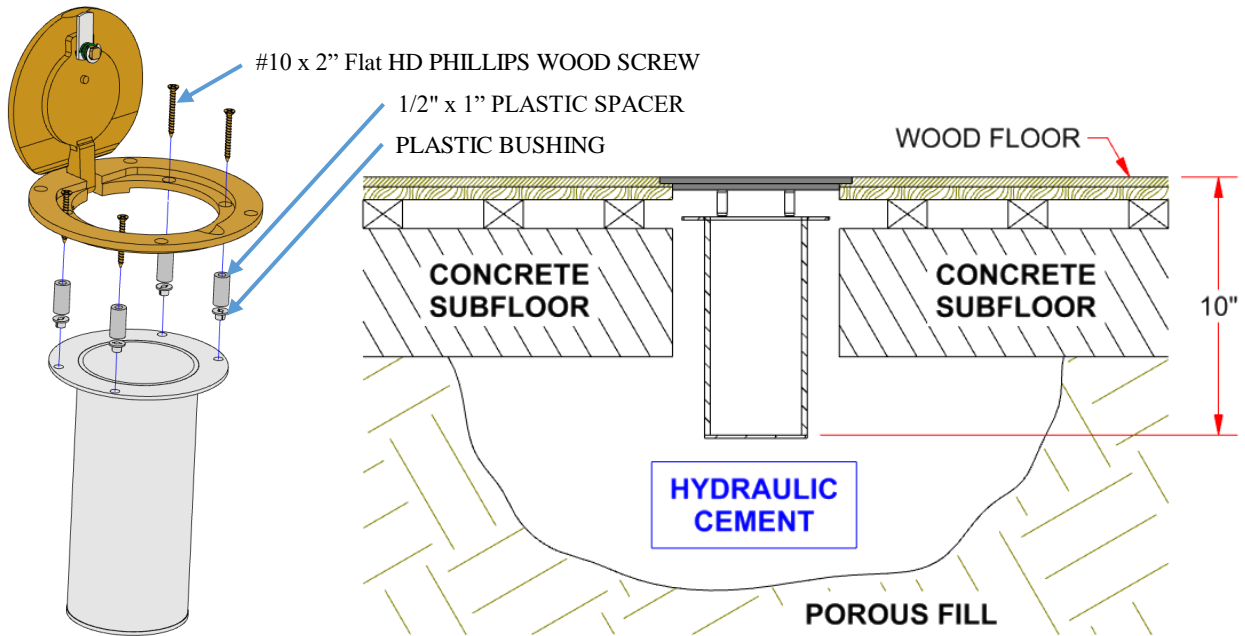

Make certain the fit is perfect before proceeding with pouring the hydraulic cement

10. Mix enough material to fill the hole completely – usually this is about $\frac{3}{4}$ of a 5 gallon bucket, or approximately 1-1/2, 50 lb container. Be sure to closely follow the manufacturer's instructions when making the mix.
11. Pour the cement into the prepared hole until it is somewhat above the bottom of the slab. Some floors have a gap between the slab and wood flooring, making this less critical. Work the sleeve into the hydraulic cement until the cover sits flush with the floor. Make sure the hydraulic cement is brought up to the top of the sleeve, but not over it.

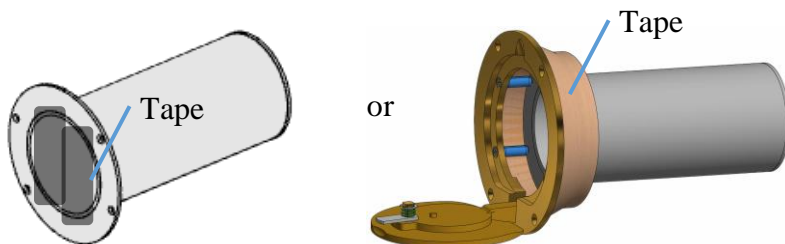

Note: Tape off the top of the sleeve with 2" wide tape to insure hydraulic cement does not overflow into the sleeve. Alternatively wrap the tape round the assembled sleeve.

12. Check the plumbness of the sleeve by using a 6' level inserted into the sleeve and up against the inner wall and side wall. Alternately, carefully lower a Volleyball Upright (pole) into the sleeve to check. Some users prefer to have the Upright SLIGHTLY leaning away from the direction of pull, or away from the court - do not exceed a 2 degree outward angle.
13. Anchor the cover plate to the wood floor using the (4) #10 x 1-1/4" wood screws.
14. Keep all activities away from the immediate area surrounding the floor sleeve for 48 hours.
15. After the hydraulic cement has set, remove and discard the temporary screws holding the sleeve to the cover plate – this will allow the floor to naturally shift over time.

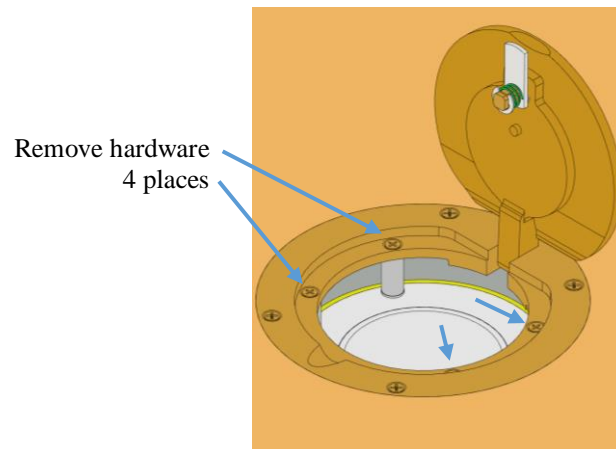

Note: Allow at least 7 days before putting the unit into service.

C. Synthetic Floors: (For installing the sleeve in a concrete slab, tile or synthetic floor)

1. Prepare the top floor surface to receive the cover plate. Draw two concentric circles centered on the center point of each sleeve – one at 6-1/2" and the other at 7-1/2". You can use the cover plate itself, laid face down (upside down) on the floor and trace its outline using a washable pen or pencil. And then offset the line 1/2" in all the way around.

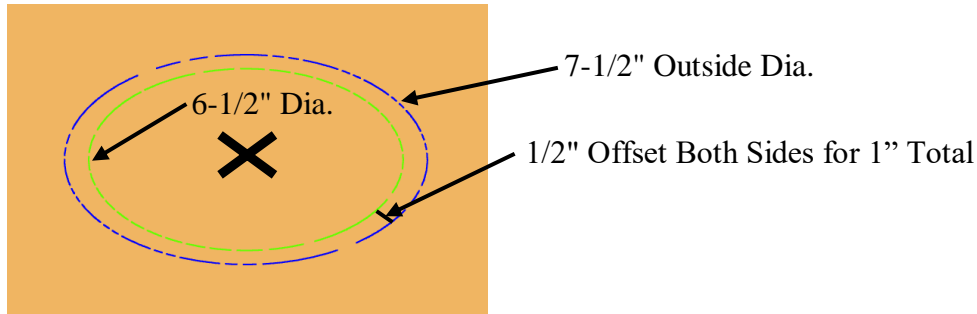

2. Carefully hand cut the flooring along the traced outline. As this is going to be an exposed, finished edge, make sure to use a very sharp blade, and proceed slowly to ensure an accurate cut. Remove all of the flooring.

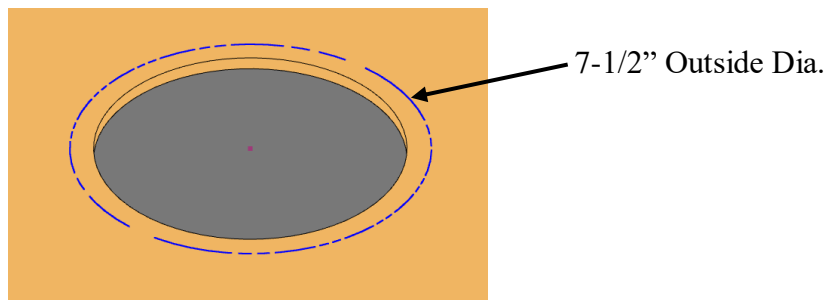

3. Carefully protect the floor, using Masonite or construction paper, taped along the edges.
4. Core and excavate the concrete as follows. Remove the concrete using a core drill and appropriate size core bit. Be sure to allow enough space to insert the top flange of the sleeve without encroaching upon the top plate area. If a core drill is not available, a series of small holes (1/2" – 3/4") will have to be drilled and the core chiseled out. This is tedious work, but necessary. Water cannot be used in close proximity to the finished floor – even a small amount of water may become trapped and result in the floor swelling. To control dust and debris, continuously vacuum the area.



- After removing the concrete, excavate the fill material below the slab. Create a minimum 16" deep "mushroom" shaped void to provide sufficient anchoring surface. Remove enough material to accommodate the sleeve, plus a few extra inches all around. Creating specialized digging tools can be very helpful to simplify this process.

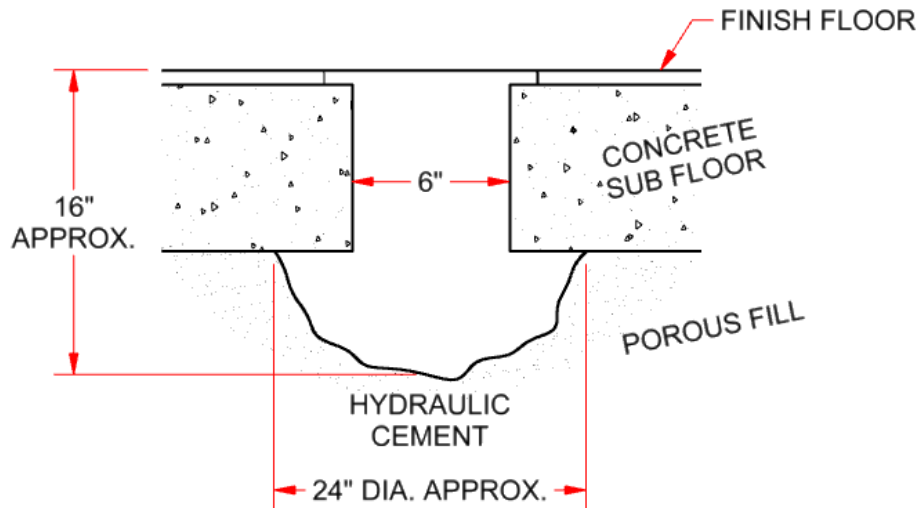

- Mark and drill four 7/32" holes into the flooring to receive the outer screws for the cover plate. These holes can be slightly oversized as the screws will be epoxied in.

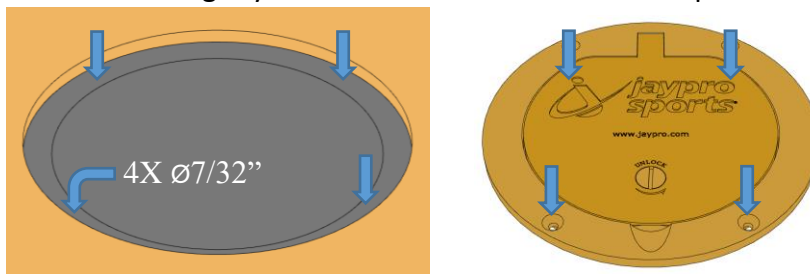

- Check to make sure the top flange of the sleeve is flat and has not been bent in shipping. Assemble the sleeve with the cover and dry fit the assembly by lowering it into the hole. Check that there is a minimum of 1" clearance between sleeve and concrete to allow hydraulic cement to lock sleeve in place. Also check fit of top plate so that it is flush with the playing surface.

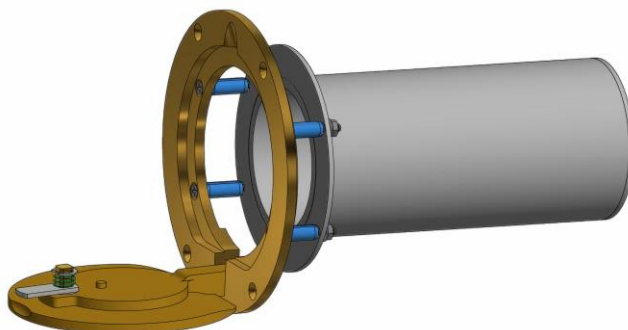
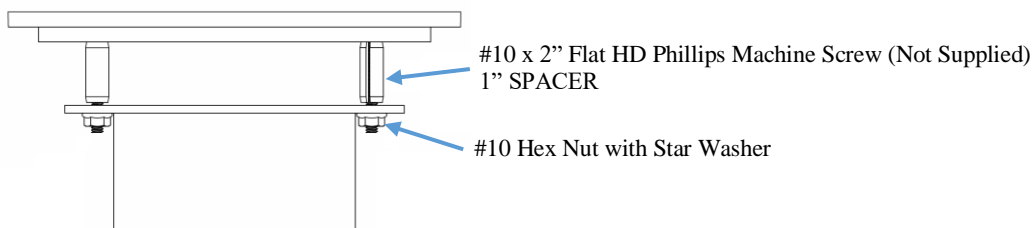

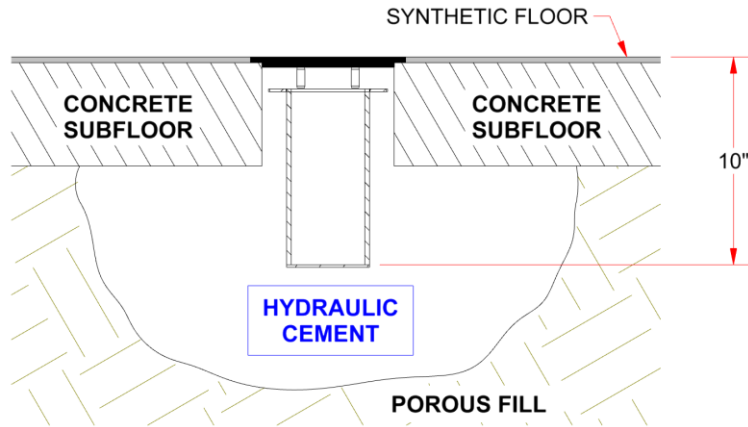

8. Mix enough material to fill the hole completely – usually this is about $\frac{3}{4}$ of a 5 gallon bucket, or approximately 1-1/2, 50 lb container. Be sure to closely follow the manufacturer’s instructions when making the mix.
9. Pour the cement into the prepared hole. Work the sleeve into the hydraulic cement until the cover sits flush with the floor. Make sure the hydraulic cement is brought up to the top of the sleeve, but not over it.

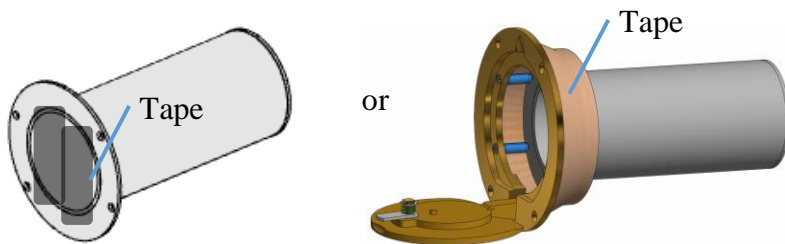

Note: Tape off the top of the sleeve with 2” wide tape to insure hydraulic cement does not overflow into the sleeve. Alternatively wrap the tape round the assembled sleeve.

10. Check the plumbness of the sleeve by using a 6’ level inserted into the sleeve and up against the inner wall and side wall. Alternately, carefully lower a Volleyball Upright (pole) into the sleeve to check. Some users prefer to have the Upright SLIGHTLY leaning away from the direction of pull, or away from the court - do not exceed a 2 degree outward angle.
11. Using a structural adhesive, install the 4 wood screws through the cover plate into the concrete floor. These screws are primarily for aesthetic purposes.

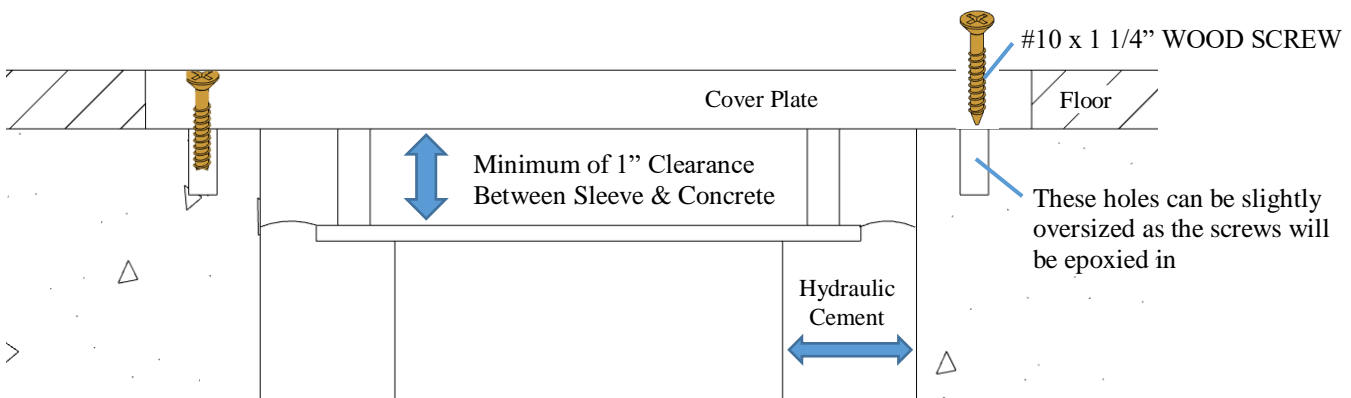

12. Keep all activities away from the immediate area surrounding the floor sleeve for 48 hours.
Note: Allow at least 7 days before putting the unit into service.